



Model No : TLY-MB-A-9XK-0D-01

Spec No.	Date	Page	Ver.
/	Feb/23/2016	1/8	A2

Jiang Xi TALOYA Technology CO. LTD.

SPECIFICATION FOR APPROVAL

Company Name: _____

Product Name: LED Round Panel Light

Part No: TLY-MB-A-9XK-0D-01

Description: AC100-240V 50/60Hz

Your Part No: _____

For customer filling			
Confirmed department.			
Confirmed result			
(Signature)			
Finally result			

Approve	Auditing	Make
Hailin Zhou	Haimin Guo	Martin Liu

SHENZHEN Add:
613, Huanancheng Development Center, Pinghu St., Longgang Dist., Shenzhen,
Guangdong, China (Mainland)
 TEL: 86-755-84669045 FAX: 86-755-84573610 Email: tw@taloya.cn www.taloya.com

Spec No.	Date	Page	Ver.
/	Feb/23/2016	2/8	A2

Product Description

- ◆ Energy saving—Have constant current driver, ultra-low power consumption, high efficiency
- ◆ Environmental—No UV & infrared radiation, Light without the heat, more soft light.
- ◆ Super bright—Use high bright LED, vertical illuminance is exceed to other factory's.
- ◆ Long life—Up to more than 20,000 hours.
- ◆ Attractive appearance—With bright appearance, non-pollution and slim and light, easily installed without fixed holder

Product Picture



Product Dimensions

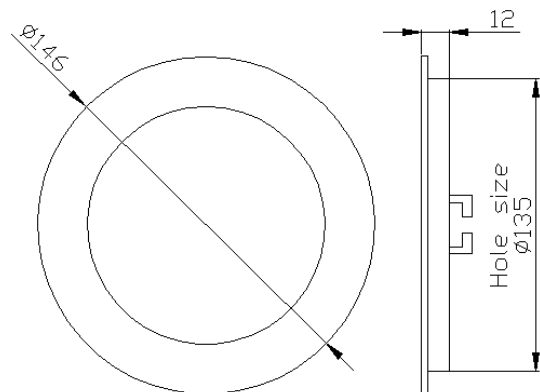

Application area

It can totally replace fluorescent lamp, applications in various areas of lighting. Such as hotels, bars, supermarkets, restaurants, museums, exhibition halls, conference room, shops, warehouses, home lighting and other places.

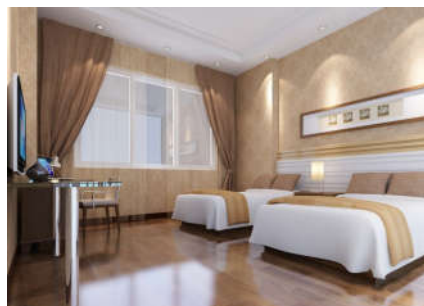

Average illumination figure

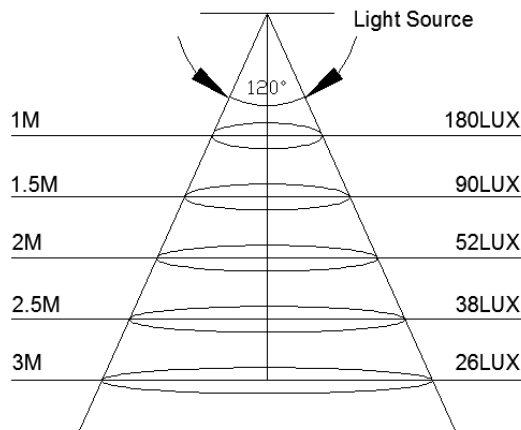

Device Selection Guide

Part No.	Color	Dom. Wavelength or CCT(Typ.)	Lumen		LED Type
			Typ.	Max	
TLY-MB-A-9CK-0D-01	Cool white	6500K	650	750	SMD 2835
TLY-MB-A-9WK-0D-01	Warm white	3000K	650	750	SMD 2835

Note: [1] If you have any special request, please contact with our salesmen.

Technical Parameter at $T_A=25^{\circ}\text{C}$

Items	Symbol	Min.	Typ.	Max.	Units
Power Consumption	P	8.5	9	9.5	W
Single loop input Voltage (AC) ^[1]	V_i	100	---	240	V
Single loop input current (AC) ^[1]	I_f	55	---	145	mA
Viewing Angle	VA	115	120	125	Deg.
Surface Temperature in Operation Condition	/	-20	---	40	$^{\circ}\text{C}$
Surface Temperature in Storage Condition	/	-40	---	55	$^{\circ}\text{C}$
Lifespan	H	---	20000	---	H

Note: [1] It is recommended to use the typical input voltage to drive LED light. The unsuitable input voltage will damage the LED light or reduce the life of product.

Spec No.	Date	Page	Ver.
/	Feb/23/2016	4/8	A2

■ Integrating sphere test data

- ◆ Cool white

Spec No.	Date	Page	Ver.
/	Feb/23/2016	5/8	A2

LED Test Report

Product Mark

Product Type :TLY-MB-A-9CK-0D-01 Manufacturer :TALOYA
 Temperature :25'C Humidity :75%
 Operator :Martin Test Date :2015-09-08

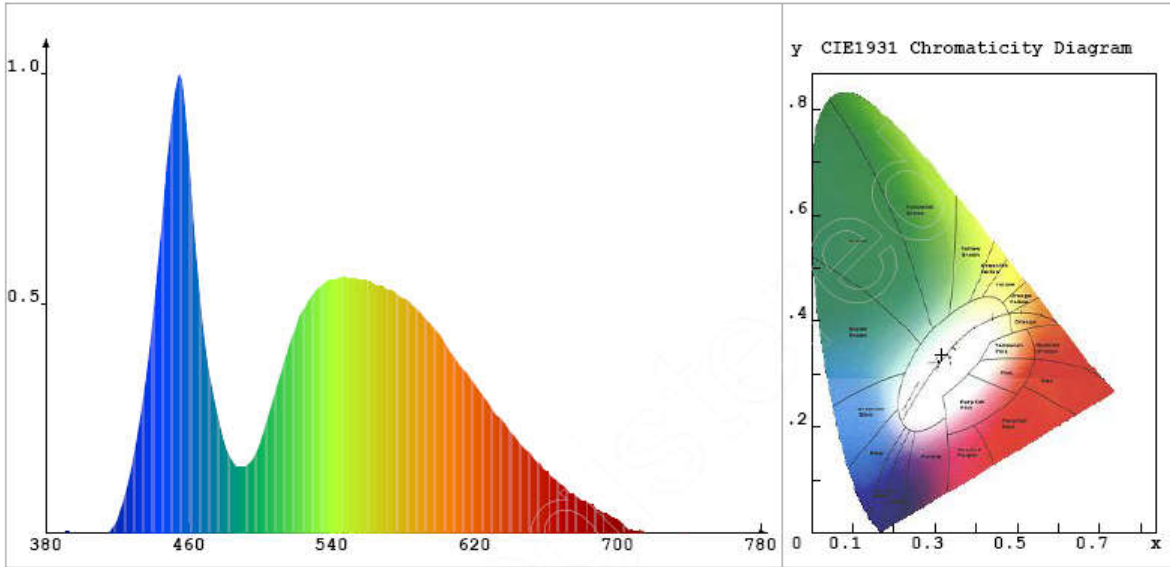

Chroma Parameters

Chro.Coor.: x=0.3162 y=0.3378 u=0.1970 v=0.3156 duv=0.0059
 CCT: Tc= 6269K Dominant Wave.: 496.1nm Purity: 5.5%
 R ratio: R= 12.3 Peak Wavelength: 454.5nm Half Width: 25.8nm

Rending Index: Ra= 73.6

R1 =69.7 R2 =79.2 R3 =83.3 R4 =70.7 R5 =69.8 R6 =70.5 R7 =85.9
 R8 =59.9 R9 =-28.0 R10=48.2 R11=65.2 R12=36.5 R13=72.1 R14=90.5
 R15=65.3

Photo Parameters

Flux: 659.75lm Effi.: 72.5lm/W RadiantPower: 2285.6mW

Ele. Parameters

Voltage:U=219.0V Current:I=0.066A
 Power:P= 9.1W Power Factor:PF=0.635

Instrument state

IntgeTime: 222.724ms VPeak: 13807 VDark: 1377
 Scan Range: 380-780nm

◆ Warm white

Spec No.	Date	Page	Ver.
/	Feb/23/2016	6/8	A2

LED Test Report

Product Mark

Product Type :TLY-MB-A-9WK-0D-01
 Temperature :25'C
 Operator :Martin

Manufacturer :TALOYA
 Humidity :75%
 Test Date :2015-09-08

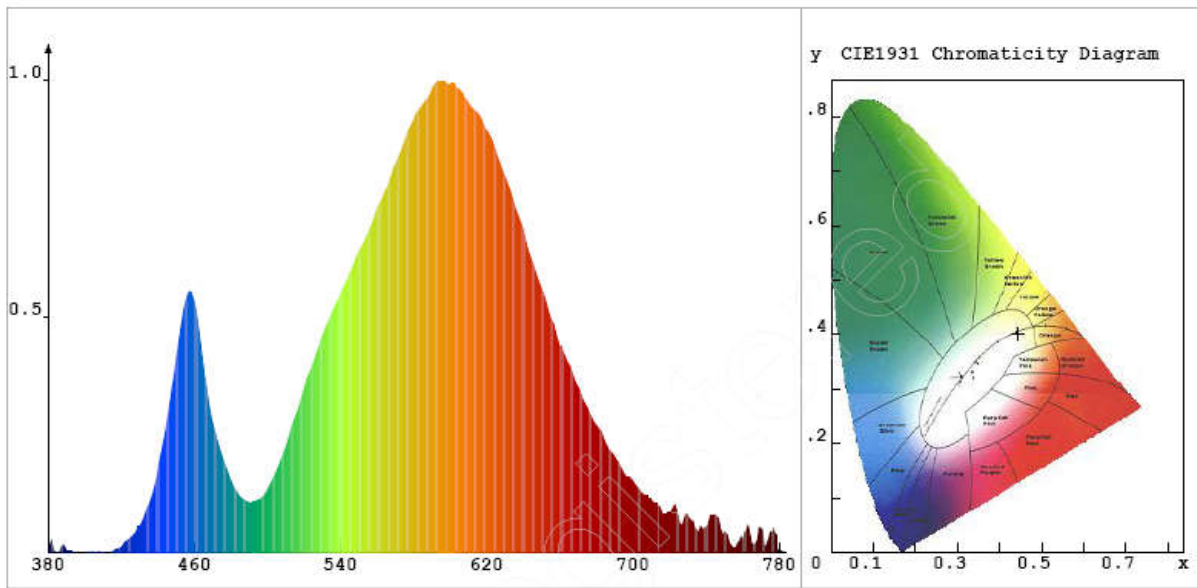

Chroma Parameters

Chro.Coord.: x=0.4447 y=0.4011 u=0.2569 v=0.3476 duv=-0.0021
 CCT: Tc= 2848K Dominant Wave.: 585.3nm Purity: 53.9%
 R ratio: R= 22.7 Peak Wavelength: 592.6nm Half Width: 120.2nm

Rending Index: Ra= 73.9

R1 =71.1 R2 =85.1 R3 =94.1 R4 =67.0 R5 =69.3 R6 =78.2 R7 =78.5
 R8 =48.6 R9 =-14.8 R10=63.5 R11=59.0 R12=50.8 R13=74.0 R14=96.5
 R15=66.0

Photo Parameters

Flux: 659.88lm Effi.: 73.32lm RadiantPower: 2856.2mW

Ele. Parameters

Voltage:U=217.0V Current:I=0.066A
 Power:P= 9.0W Power Factor:PF=0.630

Instrument state

IntgTime: 96.424ms VPeak: 9541 VDark: 947
 Scan Range: 380-780nm

Spec No.	Date	Page	Ver.
/	Feb/23/2016	7/8	A2

Connection

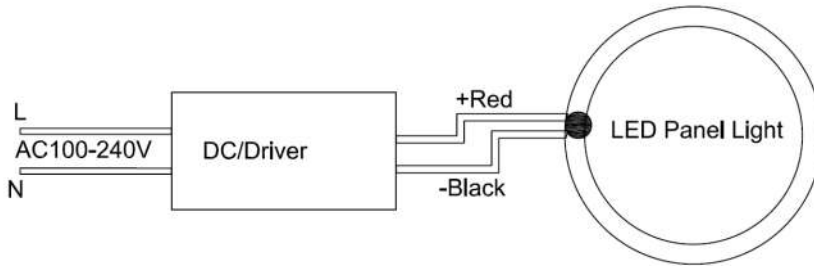

Installation Instruction

◆ **Attention:** Before installation, power must be cut off to keep people safe.

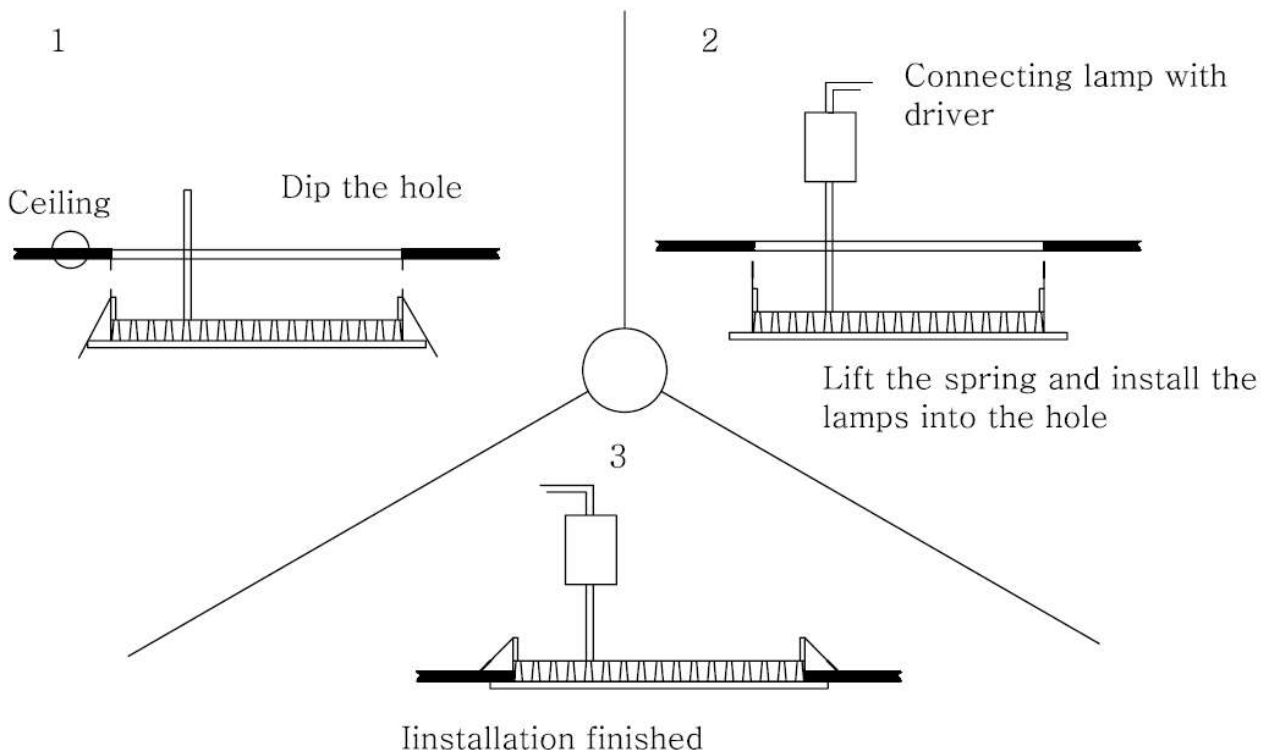

Notice: turn off the light before install or uninstall

■ The view of package

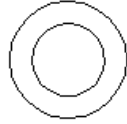

Panel light

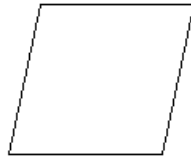

PE bag

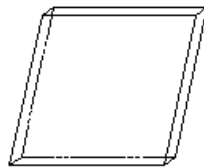

Inner box

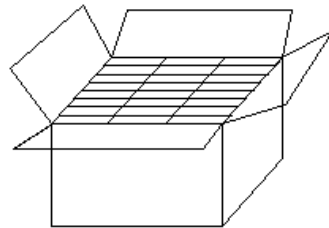

30pcs/Carton

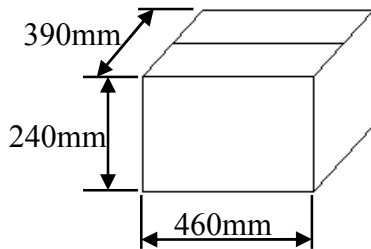

Sealed carton

Size of panel(mm)	∅ 146*12mm
Hole size(mm)	∅ 135mm
Inner box size	L*W*H: 183x214x28mm
Carton size	L*W*H: 460x390x240mm
Packing quantity	30pcs
Net weight	5.31kg
Gross weight	---kg